

POWERED by
HONDA

Paice SetterTM

Brushcutter

PS260S

***Operator's
manual***



**READ THESE INSTRUCTIONS
CAREFULLY BEFORE USE**

Please also refer to engine manufacturer's instructions.

Contact your dealer or manufacturer if you have a question that is not answered in this manual.

OBSERVE SAFETY REGULATIONS

Keep this manual safe for future reference.

E C Declaration of Conformity



Meetens Industrial Engines Ltd.,
of Unit 2, Eclipse Trading Estate, 30 West Hill, Epsom, Surrey KT19 8JD
as manufacturer, certifies that the machinery stipulated below complies with all the relevant
provisions of the:

EC Machinery Directive 98/37/EC and other relevant directives

and the National Laws and Regulations adopting this directive.

Manufacturer : Meetens Industrial Engines Ltd.
Machine description : Brushcutter
Type : PaiceSetter™ PS260S-GX25
Applicable Serial No. : 30041001 - 30042000

Harmonised standards applied: (including parts/clauses of):

EN 292 pt 1, EN 292 pt 2, EN 294 1992, EN 563 1994,
BS 7113, BS 7747, BSISO 7918, BS EN ISO 11806

Together with all relevant National Technical Standards and Specifications as applicable: -
(Including parts/clauses of):

“Responsible” Person empowered to sign:

Mr. Brian Child

A handwritten signature in black ink, appearing to read 'Brian Child', written over a horizontal line.

Position in Company: Director

Date: 01.May.2004

SAFETY WARNINGS AND DEFINITIONS

SAFETY ALERT SYMBOL



This is the Safety Alert symbol. When you see this symbol in this manual, be alert to the potential of personal injury.

When accompanied by the words 'CAUTION' and 'WARNING', it calls your attention to items or operations which can lead to serious injury.

UNDERSTAND SIGNAL WORDS and FOLLOW SAFETY INSTRUCTIONS

WARNING

You should pay special attention to these instructions since failure to do so could result in injury or death to the operator.

In this manual you will find these 'WARNING' signal words as follows:

 **WARNING:** to avoid serious injury

CAUTION

Instructions which, if not followed, could result in mechanical damage or failure.

In this manual you will find these 'CAUTION' signal words as follows:

 **CAUTION:** to avoid serious injury

NOTE

This symbol refers to an area or subject of special merit emphasising either the product's capabilities or common errors in operation or maintenance, and instructions which are of special interest.

In this manual you will find these 'NOTE' signal words as follows:

NOTE



A circular band with a diagonal slash symbol means that whatever is shown is prohibited.

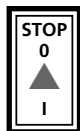

Wherever you see this symbol, the action described should only be performed with the engine stopped.

SAFETY RULES AND PRECAUTIONS

Read the Operator's Manual carefully. Be familiar with the controls and the proper use of the unit. Know how to shut the unit off and how to unhook a harnessed unit quickly.

DRESS

WARNING: to avoid serious injury





There is a risk of eye damage from thrown objects. Always wear proper eye protection in accordance with BS EN 166 : 1996 and ear muffs to BS EN 352 : 3 : 1997.

NOTE

Dress in long trousers and wear boots or safety shoes. Wear leg guards when cutting large or thorny material.

-  **DO NOT** wear open toed shoes or go barefoot or barelegged. **DO NOT** wear loose or dangling clothing, neckties, scarfs or jewellery which could be caught in the unit or the underbrush. Secure hair so that it is above shoulder length.

ENVIRONMENTAL PRECAUTIONS

-  **NEVER** allow children to operate or play with the unit. Operate only where firm footing is assured.
-  **DO NOT** operate from a ladder or any other place where use of hands would ordinarily be necessary to prevent falls.
-  **DO NOT** operate under the influence of alcohol, drugs, medications or substances which can affect your vision, dexterity or judgement. You must be physically and mentally in good health in order to operate safely.
-  **DO NOT** operate in unventilated areas. Exhaust gas is highly poisonous.
-  **NEVER** allow anyone to use the unit without proper instruction.

WARNING: to avoid serious injury

Keep people out of the danger zone. This is a circle 15 metres in radius around the unit and operator.

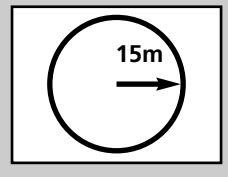
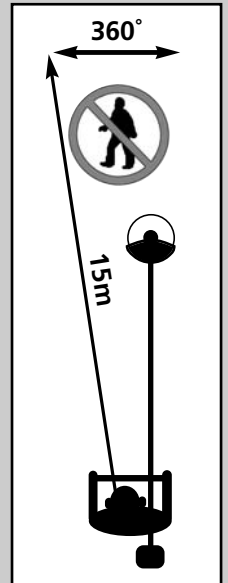

SAFETY RULES AND PRECAUTIONS

STRICTLY NO FIRE

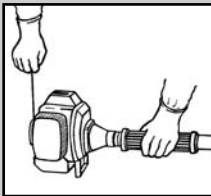

WARNING: to avoid serious injury

Handle petrol with care. It is highly flammable. Move at least 3 metres away from the fuelling point before starting engine.

DO NOT move the fuel tank cap when the engine is still warm or running.

Eliminate all sources of sparks or flame (including smoke, open flames, or work that causes sparks) in the areas where fuel is mixed, poured or stored.

Always stop the engine to refuel the tank.

Handle in a clean and cleared place and away from fire.



DO NOT smoke while handling fuel.

Always store petrol in an approved container.



DO NOT refuel a hot engine. Wait until the engine has cooled down.

Avoid spilling fuel or oil. Spilled fuel should always be wiped up.

CHECKS BEFORE STARTING

Adjust the handle to a position for comfort and keep good balance as recommend in this manual.

Make sure the unit is assembled properly.

Always use a harness when one is provided with the unit. Balance the unit as recommended by adjusting the position of the harness clamp on the shaft.



WARNING: to avoid serious injury

Hold the unit down firmly so you don't lose control while cranking. If not held down properly, the engine could pull you off balance or swing the cutting line into an obstruction or your body.

DO NOT cut with a dull, cracked or damaged metal blade.

Keep the unit and attachments in good working condition. Tighten fastening parts at regular intervals. Check the cutting head assembly before use each time.

NOTE

Thoroughly inspect the area where the unit is to be used and remove all stones, sticks, wire, bones and other objects that could cause injury if thrown at high speeds.

 **NEVER** operate the unit without proper guards, shields or other safety protective devices in place and properly connected. Inspect to determine that these safety devices are installed properly, are in good condition and operate properly. If the condition or operation of these devices are abnormal, they must be repaired or replaced before using the unit.

Make sure the cutting head stops turning when the throttle trigger is released and the engine runs at idle speed.

 **DO NOT** use any accessory or attachment other than those supplied by the manufacturer for use with this particular unit.

Use only for jobs explained in this manual.

Inspect the entire unit before using each time for worn, loose or damaged parts.

 **DO NOT** use until the unit is in proper working order.

 **DO NOT** attach any blade to a unit without proper installation of all working parts.

CAUTIONS DURING OPERATION

If it is necessary to cut where people or cars could be hit by thrown objects, cut at reduced (slow) throttle speed to reduce the speed of the cutting head.



CAUTION: to avoid serious injury

Shut down immediately if the unit starts to shake or vibrate. This could be a sign of danger from a broken part or missing fasteners.

Disconnect the spark plug lead before you work on the unit or leave it unattended.



Always keep both hands on the control handles.

DO NOT operate one-handed.



DO NOT hold material you are cutting.



WARNING: to avoid serious injury

After shutting down the engine, keep fingers and feet away from the cutting head until all rotation stops.

NEVER use wire in place of the nylon monofilament cutting lines.

The wire tip can break off during cutting and become a dangerous missile.

DO NOT put hands or feet near or under rotating parts while engine is running.



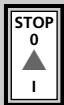
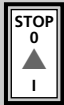
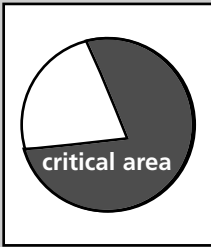

WARNING: to avoid serious injury

Blade thrust may occur when the spinning blade contacts a solid object in the critical area. A dangerous reaction may occur causing the entire unit and operator to be thrust violently. This reaction is called BLADE THRUST. As a result, the operator may lose control of the unit which may cause serious or fatal injury. Blade thrust is more likely to occur in areas where it is difficult to see the material to be cut.

To avoid hitting small stones or other debris, do not cut too close to the ground.

Keep cutting attachment below waist level.

After striking a foreign object or if the unit vibrates abnormally, stop the engine, disconnect and secure the spark plug lead. Inspect the unit for any damage and repair the damage.

Cover the blade when storing or during transport.

PRECAUTIONS AFTER OPERATION



WARNING: to avoid serious injury

DO NOT store the unit with fuel in the tank, because a fuel leak could start a fire. Allow the engine to cool before storing in any enclosure.

NOTE

Before cleaning, repairing or inspecting, make certain the cutting head has stopped. Disconnect and secure the spark plug lead away from the plug to prevent accidental starting.

Use only recommended genuine replacement parts to avoid creating a hazard and/or voiding your warranty.

Store in a dry area out of the reach of children.

CONTENTS

Safety Warnings and Definitions	3
Safety Rules and Precautions	4

SECTION 1 - OPERATION

Preparing for Operation	10
Starting and stopping the engine	11
Adjustments	13
Correct handling of the machine	14
Working methods	15
Preventing kickback	16
Regular maintenance	17
Selection of rotary cutters	19
Storage	20
Trouble-shooting	20

SECTION 2 - ASSEMBLY & INSTALLATION

Installation

Installation of engine	22
Installation of cutter	23

SECTION 3 - PARTS SPECIFICATIONS

Parts specifications	26
Limited Warranty	31



CAUTION: to avoid serious injury

Carefully follow the instructions in this manual to avoid any mistakes. We shall not be held responsible for any accident due to any operational error resulting from negligence in following the instructions, nor for any accident due to repair, remodelling, overhaul etc., by anyone other than our authorised dealers.

NOTE

Because of differences in the various engines that can be fitted to our brushcutters, according to specification, the diagrams referring to engines are intended as a pictorial guide only and are not necessarily specific to a particular machine. Some details may differ slightly.

For full details regarding the engine, please refer to the engine manufacturer's instructions.

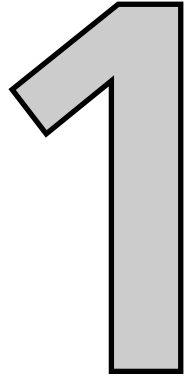

SECTION 1

OPERATION

PREPARING FOR OPERATION



CAUTION

1. **NEVER** fill the fuel tank to the very top.
2. **NEVER** add fuel to the tank in a closed unventilated area.
3. **DO NOT** add fuel close to open fire or sparks.
4. Wipe off spilled fuel before starting engine.
5. **DO NOT** attempt to refuel a hot engine.

Checks before operation

1. Check for loose bolts, nuts and fittings.
2. Check the air cleaner for dirt and clean before operation.
3. Check to ensure that safety guard is securely in place.
4. Prior to operating Honda 4-stroke engines, check the oil level and continue to check after every 10 hours of operation; top up as necessary.

SAE 10W-30 recommended for general all temperature use.



CAUTION

Using nondetergent oil or 2-stroke engine oil in a 4-stroke engine could shorten the engine's service life.

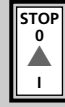

STARTING & STOPPING THE ENGINE

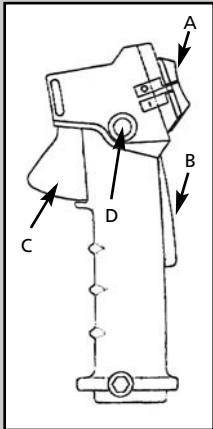

NOTE

The follow information is only a guide.

For definitive instructions regarding the engine, always refer to the engine manufacturer's instructions.

Starting (Before starting, see Safety Rules on page 4)

CAUTION

Release the lock lever before operating the half throttle button. Forcing the half throttle button may damage it.

Place the machine on a level, firm, dry surface, taking care that the cutting tool does not come into contact with the ground or any other objects.

Slide the ignition cut-off switch (A) to the 'ON' position [I].

Grip the throttle control (Holding the handle activates the safety lever (B)) and squeeze the throttle trigger (C).

Press the half throttle button (D) on the side and release the throttle trigger.

Press the priming button repeatedly in order to pump the fuel and ensure smooth starting.

Move the choke lever to the fully closed position.

Grasp the recoil starter knob and pull it sharply.

CAUTION: to avoid serious injury

DO NOT pull the recoil starter completely but leave a little margin. Return slowly after pulling.

After starting, monitor the engine behaviour and move the choke lever slowly to the fully open position. When the engine fires but does not start, move the choke lever to the fully open position and and pull the starter knob sharply again.

After the engine starts, grip the throttle control and press the trigger which will release the half throttle button and return the engine to low speed (idle).

Move the throttle lever to low speed (idle) position and let the engine warm up for about one minute.



CAUTION: to avoid serious injury

The cutter blade or nylon cutting head should not rotate when the throttle lever is fully released and the engine returned to low speed (idle).

If necessary, adjust the idle RPM using the idle adjusting screw (page 13).

- Please refer to the engine manufacturer's instructions or consult your PaiceSetter dealer.



CAUTION

Since the engine is not well lubricated just after starting, avoid rapidly increasing the engine speed at this time.

When the throttle is fully open, RPM is very high and may cause engine failure.

DO NOT race the engine and avoid unnecessarily high running speeds.

Stopping

Release the throttle lever.

Shift the main switch from the [I] position to the [O] position.

If no more work is to be carried out, evacuate the fuel from the fuel tank, restart the engine and continue to operate until it stops. The fuel remaining in the float chamber of the carburettor will be consumed in about 2 or 3 minutes and the engine will stop. Exhausting the fuel in the carburettor will ensure an easier start-up next time.



WARNING: to avoid serious injury

During summer months, be careful that the inner packing of the fuel tank cap is not submerged in the fuel. If the air hole is submerged, the fuel may leak due to the increased pressure inside the fuel tank.

During operation and just after stopping, do not touch the engine unit, especially the exhaust.

CARBURETTOR ADJUSTMENT

For details of carburettor adjustment, please refer to the engine manufacturer's instructions supplied with your main pipe assembly.

CAUTION

Adjustment of the carburettor is not usually necessary, since it is adjusted to the optimum position when delivered from the factory.

If the fuel mixture is adjusted extremely lean, it may cause seizure of the engine.

ADJUSTING THE IDLING SPEED

If the engine tends to stop frequently at idle speed, turn the adjusting screw clockwise.

It is normal for the engine to keep running without the blade rotating when the throttle lever is released. If the engine speed is too high or too low, readjust the idle set screw.

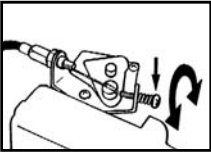

NOTE

Warm up the engine before adjusting the idling speed.

CORRECT HANDLING OF MACHINE

Attaching the shoulder harness

Put on the shoulder harness and connect the buckle, ensuring that it is properly fastened. Attach the brushcutter to the harness and adjust the strap length so that the cutter blade or the nylon cutting head will be kept parallel to the ground.

Releasing the shoulder harness

In an emergency, pull the release belt strongly upward to detach the machine from you. Be extremely careful to maintain control of the machine at this time.



DO NOT allow the machine to be deflected toward you or anyone in the vicinity.



WARNING: to avoid serious injury

Failure to maintain complete control of the machine at all times could result in serious bodily injury or death.

NOTE

Use the hook to connect and disconnect the brushcutter. **DO NOT** use the quick release mechanism except in emergency.

Handling

Hang the machine on the right side of your body.

Squeeze the throttle lever, and the rotational speed will be increased. Release it and the engine will run at low speed (idle). Use a rotational speed suitable for the grass being cut. If the rotational speed is excessively low, grass may become jammed in the cutter blade.

During grass cutting, hold the machine firmly to permit easy, controlled handling.



NEVER strike or tap objects with the cutter blade or the nylon cutting head.

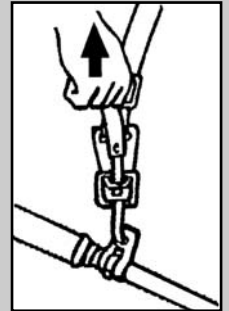
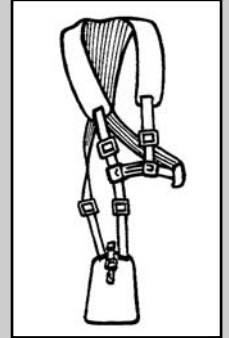

WORKING METHODS



WARNING: to avoid serious injury

Always wear safety goggles, safety shoes, gloves and helmet whenever operating the machine.

Nylon cutter

Pull out the cord of the nylon cutter by 12-15cm.

Blade

Blades can be sharpest from the edge to one third up the shaft. When mowing grass, use two thirds.

Working methods

Since the blade rotates anti-clockwise as seen from above, it is more efficient to mow grass from right to left (see 'scything' diagram).

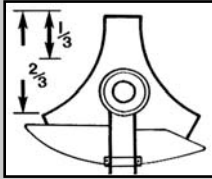

scything

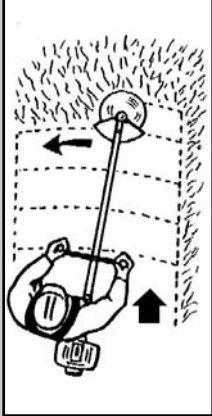

scything



scalping

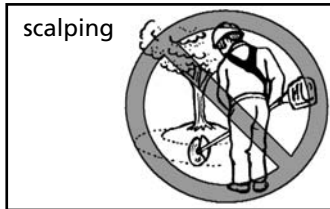

edging

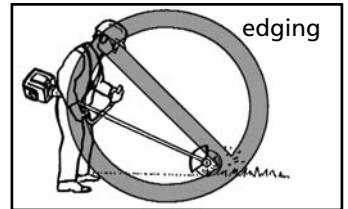

WARNING: to avoid serious injury

If the rotary blade hits any hard object such as a stone, stop the engine and check that the blade is not cracked.

DO NOT use any type of blade for edging or scalping. Use only nylon line.

Always check that there is a safe distance between the cutter and your feet.

WORKING METHODS (continued)

Kickback



WARNING: risk of serious injury

When operating the brushcutter, uncontrolled kickback may occur.

Kickback can occur particularly when attempting to cut within a blade segment between 12 and 2 o'clock.



NEVER apply the brushcutter within a segment between 12 and 2 o'clock.

NEVER apply this segment of the brushcutter blade to solid objects such as trees, bushes etc., with a diameter exceeding 3cm. Otherwise the brushcutter will be deflected at great force with the risk of injuries.

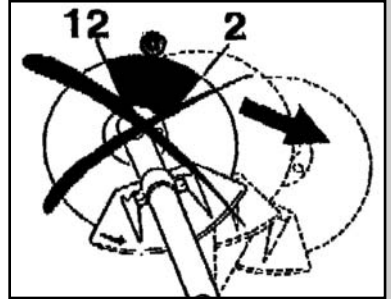

Preventing kickback

To avoid kickback, observe the following:

Operating within the blade segment between 12 and 2 o'clock risks definite hazards, especially when using metal cutting tools.

Cutting operations within a blade segment between 11 and 12 o'clock, and between 2 and 5 o'clock must only be carried out by experienced, trained operators, and only at their own risk.

Easy cutting with little risk of kickback is possible within a blade segment between 8 and 11 o'clock.

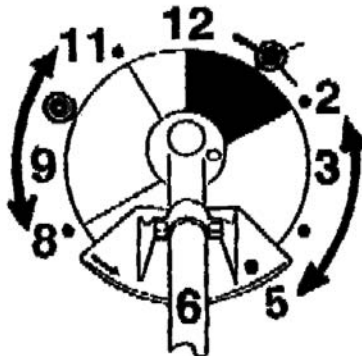

REGULAR MAINTENANCE CHART

	Note	Before work	After work	Every 25 hrs	Every 100 hrs	Every month
COMPLETE UNIT						
Visual inspection	1	★				
Clean			★			
CUTTING TOOL*						
Inspect cutters	1	★				
Check tightness	1	★	★			
THROTTLE						
Check operation of trigger, ignition switch & throttle lock	1	★				
BOLTS						
Inspect & re-tighten	1	★				
SHAFT TUBE						
Visual inspection	1	★	★			
SAFETY GUARD						
Visual inspection	1	★				
GEAR CASE						
Clean			★			
Apply grease	3			★		
CLUTCH DRUM						
Clean					★	
*AIR INLETS						
Visual inspection	2	★				
Clean	2		★		★	
*FUEL TANK						
Replace filter element					★	
Clean tank						★
*AIR FILTER^R						
Clean	2	★			★	
*EXHAUST INLET & OUTLET						
Clean	4			★		
*CARBURETTOR						
Check idle adjustment (readjust as required)	5	★				
*SPARK PLUG^R						
Check electrode gap (readjust as required)	6			★		
(Replace spark plug twice a year)						

* For engine maintenance details, refer to engine manufacturer's instructions.

^R Replace part if damaged

REGULAR MAINTENANCE NOTES

For engine maintenance details, please refer to the engine manufacturer's instructions.

1. Before operation

Check the machine for loose screws or missing parts. Pay particular attention to the tightness of the cutter blade. (See page 23 - 'Installation of cutter'.)

Always check for clogging of the cooling air passage and the cylinder fins. Clean them if necessary.

2. Cleaning the air cleaner

Remove the air cleaner cover and clean the sponge element. If there is excessive dust or dirt adhering to the air cleaner, clean it every day. A clogged air cleaner may make it difficult or impossible to start the engine or increase the engine rotational speed. Install the sponge element around the ribs of the air cleaner case.

3. Applying grease

Apply grease to the gear case through the grease hole every 25 hours.

For grease, use lithium type grease No.2 or equivalent.



CAUTION: to avoid serious injury

The gear casing will be hot during and after operation - allow it to cool sufficiently before touching.

4. Cleaning the exhaust port

Check the exhaust port every 50 hours. If the exhaust port is clogged with carbon, remove it by scraping and tapping gently with a screwdriver.

5. Carburettor adjustment

For details on adjustment of the carburettor, please refer to the engine manufacturer's instructions.



CAUTION

Adjustment of the carburettor is not usually necessary, since it is adjusted to the optimum position when delivered from the factory.

If the fuel mixture is adjusted extremely lean, it may cause seizure of the engine.

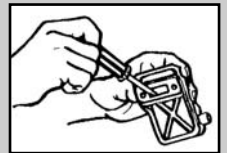
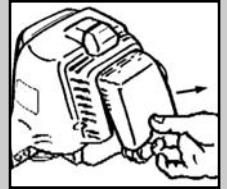

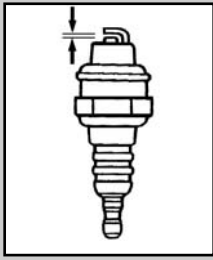

6. Checking the spark plug

The spark plug may gather carbon deposits on its firing end with reasonable use. Remove and inspect the spark plug every 25 hours and clean the electrodes as necessary with a wire brush. For the correct spark plug gap, please refer to the engine manufacturer's recommendations. If the gap is too wide or too narrow, adjust it. Plug manufacturers recommend replacing the plug twice a year to avoid unexpected plug failure.

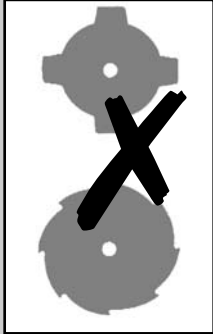

Re-sharpening the cutter blade

CAUTION

The star blade (4 teeth) and eddy blade (8 teeth) cutting tools must only be re-sharpened by an authorized facility. Manual re-sharpening will result in an imbalance of the cutting tool causing vibration and damage to the equipment.

If in doubt, replace blade or consult your local dealer.

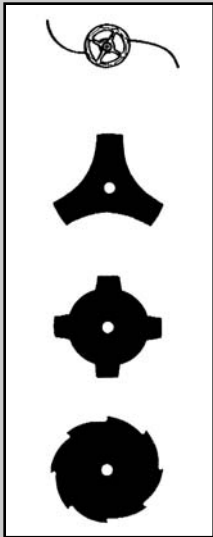

SELECTION OF ROTARY CUTTERS

Select the blade best suited to the purpose:

Cutter type	Application
2 line nylon cutter	soft and low weeds
3 blade cutter	relatively low weeds
4 blade cutter	relatively low weeds
8 blade cutter	relatively hard weeds

Use only BS 7113 approved blades

WARNING: to avoid serious injury

DO NOT cut wood and twigs with 3-toothed blade, 4-toothed blade or 8-toothed blade.

If in doubt, consult your local dealer for advice.

STORAGE

When storing the machine for a long time, drain fuel from the fuel tank and carburettor as follows:

Drain all fuel from the fuel tank. Give a gentle push on the primer pump repeatedly until all fuel is expelled out of the primer pump. Dispose of properly and in accordance with all local laws.

Remove the spark plug and add a few drops of oil into the spark plug hole. Then, pull the starter gently to ensure that an oil film coats the engine inside; then tighten the spark plug.

Clean or blow dirt or dust from the cutter blade and outside of engine, wipe them with an oil-immersed cloth and store the machine in a dry location.

TROUBLESHOOTING

1. Machine does not start:

- a) Check that water, etc. is not mixed in with the fuel.
- b) Check that the intake of fuel is not excessive.

2. Rotating speed does not increase after starting:

- a) Check if the choke is fully open.
- b) Check that the mixing ratio of fuel is correct.
- c) Check that water, etc. is not mixed in with the fuel.

3. Output is insufficient even if rotation continues:

- a) Check if the element of the air cleaner is stained.
- b) Check that the exhaust part of the cylinder and the inlet and outlet of the exhaust are not clogged with carbon.

4. Machine gradually slows down and stops during use:

- a) Check that the air vent hole of the fuel tank is not clogged with dust etc..
- b) Check that the fuel system is not blocked by dust etc.
- c) Check that water, etc. is not mixed in with the fuel.

If the problem persists after following the above checks, please consult your local dealer.



SECTION 2

INSTALLATION

ASSEMBLY OF THE MACHINE

Installation of engine

1. Attach the clutch case to the engine with the 4 Allen screws (in tool bag).
2. Remove cable adjuster and nut from carburettor adjuster bracket and replace with the cable adjuster fitted to the brushcutter throttle cable.
The procedure may be easier if the air filter cover is removed.
3. Slide inner throttle cable into carburettor throttle arm.
4. Adjust the play of the throttle wire as detailed below.
5. Connect ignition wires.

ref. Honda GX25

In essence the procedure is the same as listed above with the exception of the method of fixing the brushcutter cable adjuster.

1. Remove air filter cover.
2. Separate the adjuster locknuts 5mm
3. Insert inner cable into carburettor throttle arm.
4. Place cable adjuster between engine cowl adjuster holding forks and finger tighten nuts and adjust the play of the throttle wire to between 0.5mm - 1.0mm. and lock nuts.

NOTE: Excessive play will cause starting failure.

5. Connect ignition wires and replace air filter cover.

Adjusting the throttle wire

Using the throttle cable adjuster nut, adjust the play of the throttle wire to between 0.5mm - 1.0mm and lock nuts.

NOTE: Excessive play will cause a starting failure.

If your machine differs from that shown, please refer to the engine manufacturer's instructions.

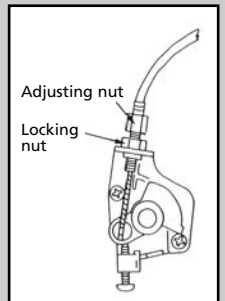
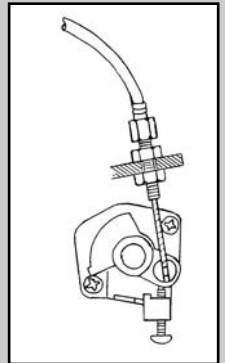

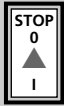

Installation of cutter



CAUTION: to avoid serious injury

Blade is sharp. Please handle carefully to avoid injury.

BLADE

1. Assemble parts in the following order:
holder A, blade, holder B, guard, fastening nut.
2. In order to lock the rotation of the spline shaft, align the holes (x) of gear case and holder A and insert bar wrench.
3. Rotate the blade-fastening nut with a plug box wrench counter-clockwise until securely tightened. (Recommended torque - 30 Newton Metres).

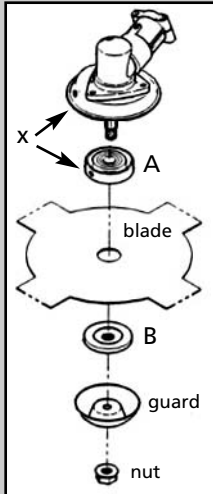

NYLON CUTTER

1. When fixing the nylon cutter, assemble parts in the following order:
holder A, holder B, adaptor bolt, nylon cutter.
2. As in the case of fixing the blade, insert bar wrench to lock the rotation of the spline shaft.
3. Rotate the nylon cutter counter-clockwise until securely tightened.



WARNING: to avoid serious injury

Stop the engine before attaching or detaching the blade.

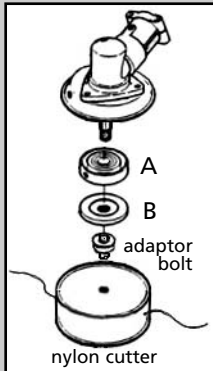

NOTES

3

SECTION 3

PARTS SPECIFICATIONS

PS-260 S

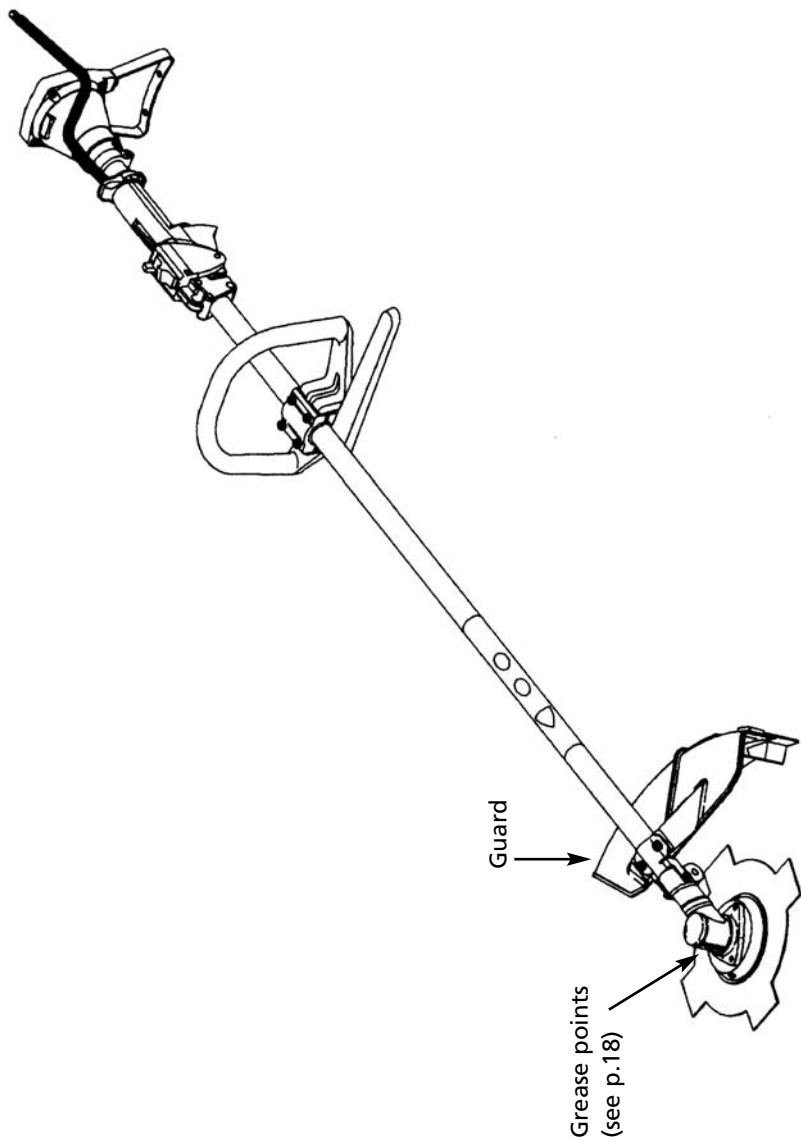

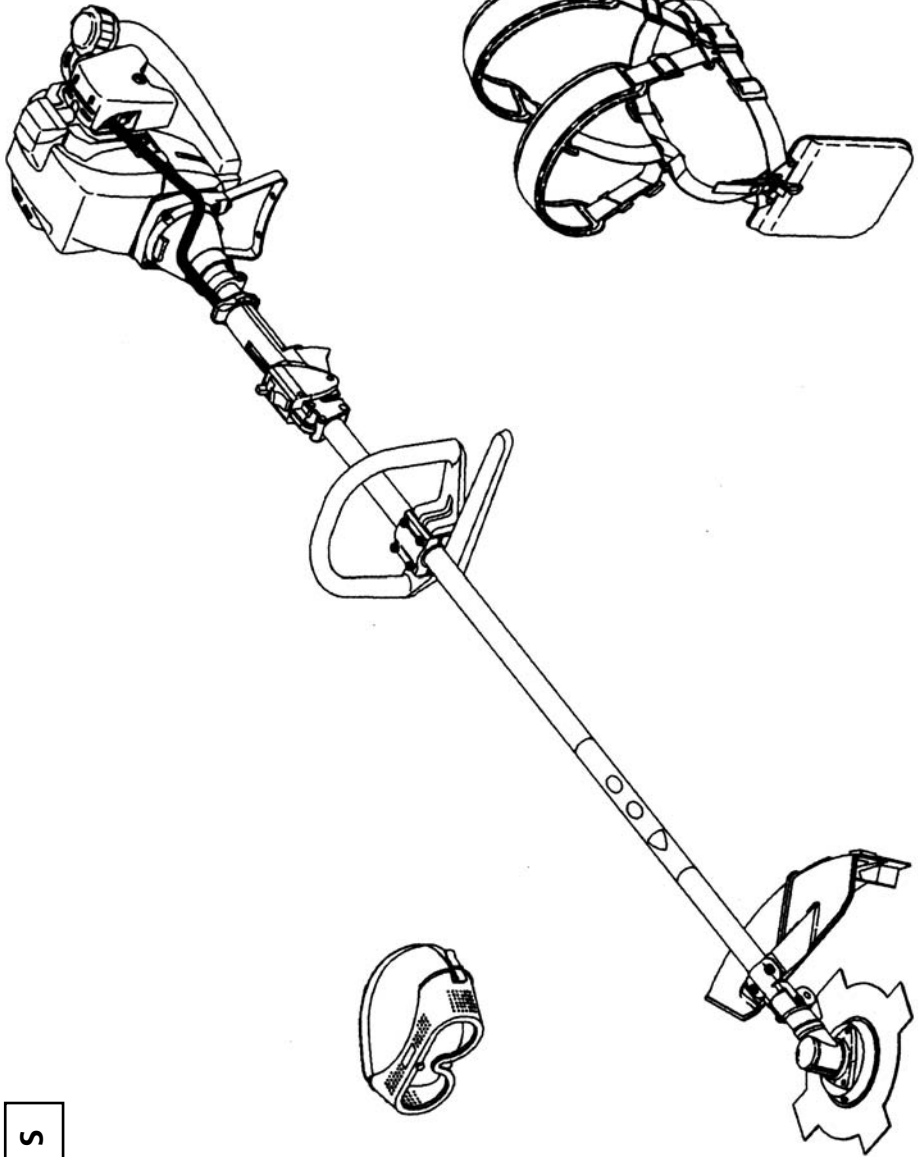

PS-260 S

PARTS DIAGRAM

MODEL: PS-260 S

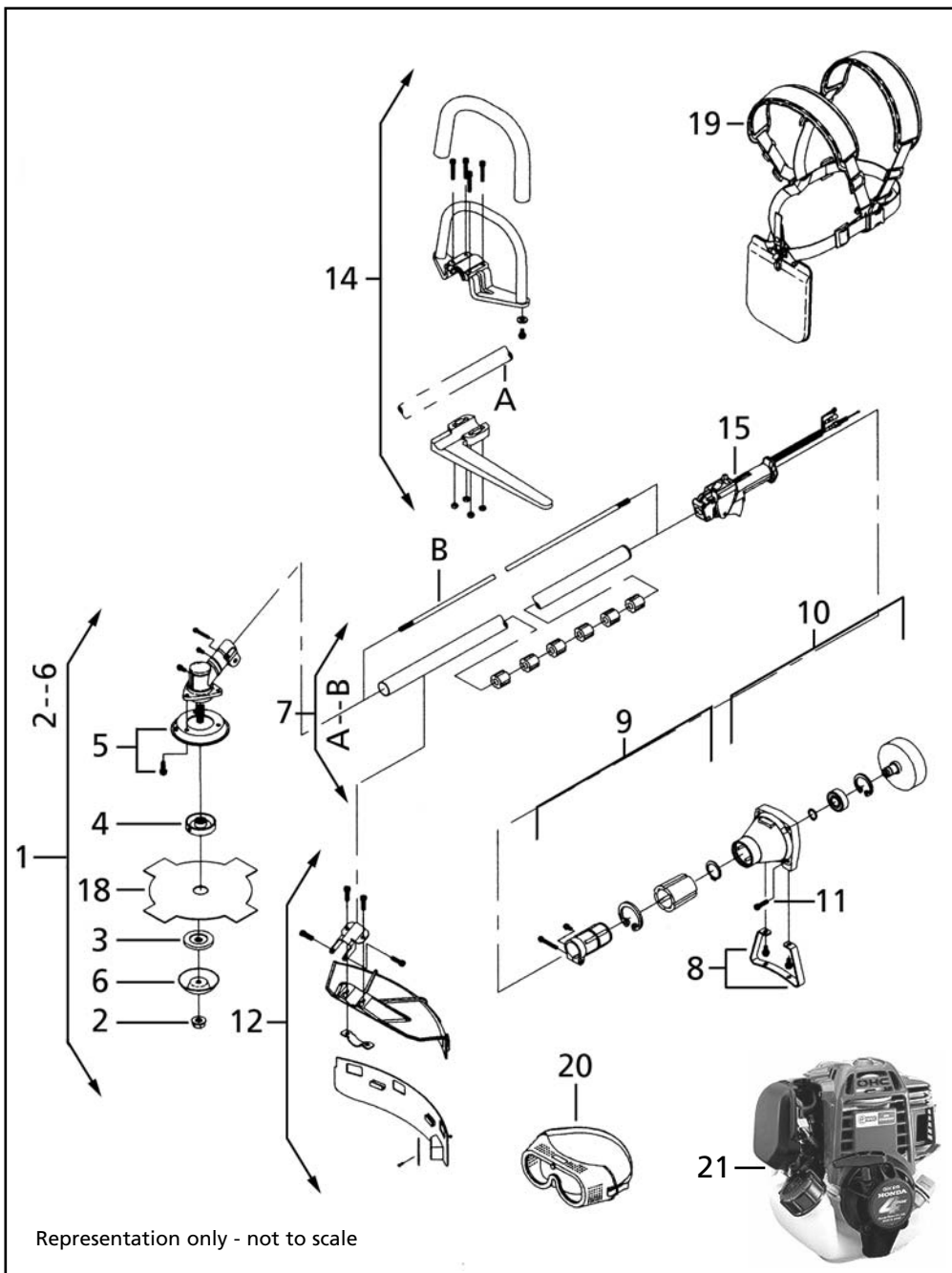

Representation only - not to scale

PARTS LIST

MODEL: PS-260 S

(Quote Year of Manufacture: 2004)

No.	Part No.	Part Description
1	PS26-0104	Gear Case Assembly (includes 2-6)
2	PS10-0204	Blade Locking Nut 10mm
3	PS26-0304	Blade Holder-B
4	PS26-0404	Blade Holder-A
5	PS26-0504	Grass Cover, Gear Case (includes fixing screws)
6	PS26-0604	Guard, Blade Nut
7	PS26-0704	Main Pipe Assembly (includes A-B)
8	PS26-0804	Brush cutter Stand (includes fixing socket screws)
9	PS26-0904	Anti-Vib Boss Assembly (includes rubber and all circlips)
10	PS26-1004	Anti-Vib Clutch Housing Assembly (includes Drum and bearing)
11	PS26-1104	Socket Bolt SPWS M6x30
12	PS26-1204	Safety Guard Assembly (includes detachable skirt)
13		
14	PSS-1404	Loop Handle Set, Ergonomic (includes Anti-Vib Grip)
15	PSS-1504	Throttle Lever Assembly (includes throttle cable)
16		
17		
18	PSPB-1804	4T Plastic Blade 255mm (25.4) (Subject to Specification)
19	PS26-1904	Shoulder Harness Assembly
20	PSG-1604	Goggle (CE)
21	GX25	HONDA 4 Stroke 25cc Over-head Valve Petrol Engine

NOTES

LIMITED WARRANTY

Should any failure occur with the product under normal operating conditions within the applicable warranty period, the failed part will be replaced or repaired free of charge by your authorised dealer.

WARRANTY PERIOD:

Main pipe assembly:

2 years from the date of initial purchase.

Engine:

All engines supplied with these brushcutters are covered by the appropriate engine manufacturer's warranty. **Refer to the documentation supplied with the engine.**

IMPORTANT:

The following cases are not covered by this warranty:

- a) Any failure resulting from neglect of the instructions for proper operation and maintenance of the equipment as described in the operator's manual.
- b) Any damage due to accidents, abuse, negligence, alteration, or use of any parts or accessories other than those specified.
- c) Any failure due to use of improper fuel.
- d) Replacement of normally consumed parts: spark plugs, filters, starter ropes, etc.
- e) Regular maintenance and adjustments explained in the operator's manual.
- f) Incidental or consequential damages.
- g) Transportation costs for the failed/repaired unit.

Nothing contained in this warranty affects the consumer's statutory rights.



ENGINE:

HONDA

GX25

ENGINE SERIAL No.:

VIBRATION:

4.5(L) - 5.1(R) m/s²

Please keep the information on this page safe and refer to these details in the event of any queries.

Purchaser's Name:

Address

Postcode:

Dealer:

date of purchase:

Manufactured and distributed by:

Meetens Industrial Engines Limited

Unit 2 Eclipse Trading Estate,

30 West Hill, Epsom, Surrey KT19 8JD

Tel: +44(0)1372 745274 Fax: +44(0)1372 741447

e-mail: sales@bessertrim.com